

ecocirc XL 32-80 F

Données techniques

Company name
Contact
Phone number
E-Mail

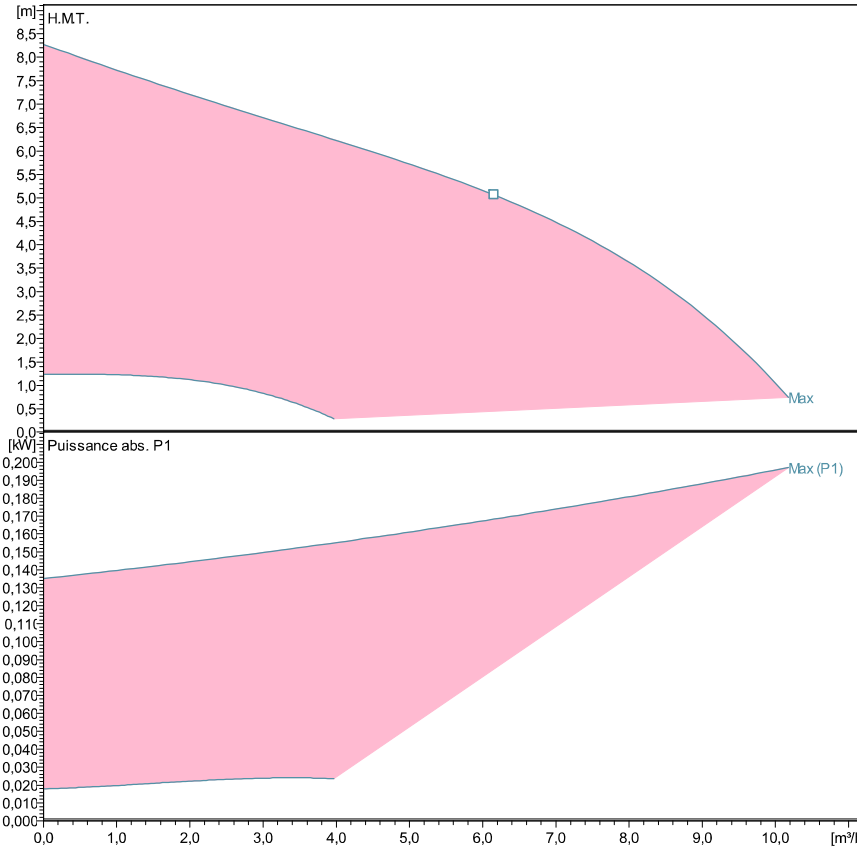

Performances selon ISO 9906: 2012 - Grade 3B

Liquid temperature:

Caract. de puissance d'après:
Eau, claire [100%]; 4°C; 1000kg/m³; 1,57mm²/s

-10°C (14°F) to +110 °C (230°F) for heating pumps
-10°C (14°F) to +85 °C (185°F) for domestic hot water pumps



Caract. pompe

Constructeur	Lowara
Port to port (mm)	220
Electrical connection	Bornes
Specific EEI	<= 0,23
Nominal pressure	PN 6/10
Connection	Bride / DN 32

Electrical data

Tension nom.	230 V
Fréquence	50 / 60
Protection class	IP 44
Classe isolation	F
Digital input	Contact load: 5V, 10 mA
Digital output	Vmax < 250 VAC / Imax < 2 A
Analog input	0-10 V / 4-20 mA
Courant de fuite	< 3.5 mA
Communication capabilities	Pas de protocole de communication
Sound pressure level	<= 45 dB(A)
Intensité nom.	1,4 A

Matériaux

Palier	Carbone, imprégné de résine	roue	PPS
Thrust bearing	Aluminium	Wear ring	Acier inox
Plaque de roult	Acier inox	Rotor can	Acier inox
Carter moteur	Aluminium	Arbre	Acier inox
Joints toriques	EPDM	Boitier	Poly carbonate
Corps de pompe	EN-GJL		

Dimensions mm

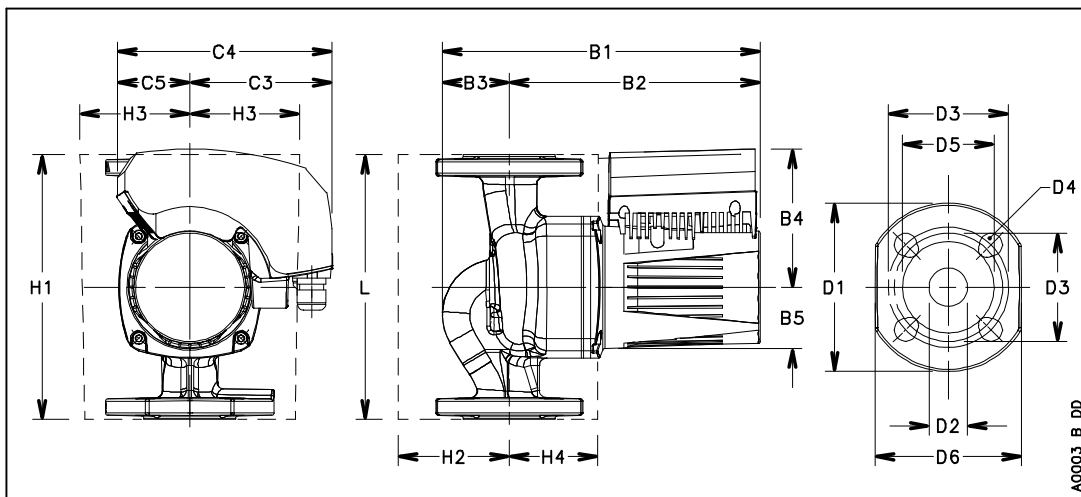

B1	266
B2	208
B3	58
B4	118
B5	51
C3	116
C4	178
C5	62
D1	140
D2	32
D3	90/100
D4	4 x 14/19
D5	76
G	DN 32
Gross Weight	13,3
H1	220
H2	94
H3	96
H4	76
L	220
Net Weight	9,8