

ecocirc XL 40-180 F

Données techniques

Company name
Contact
Phone number
E-Mail

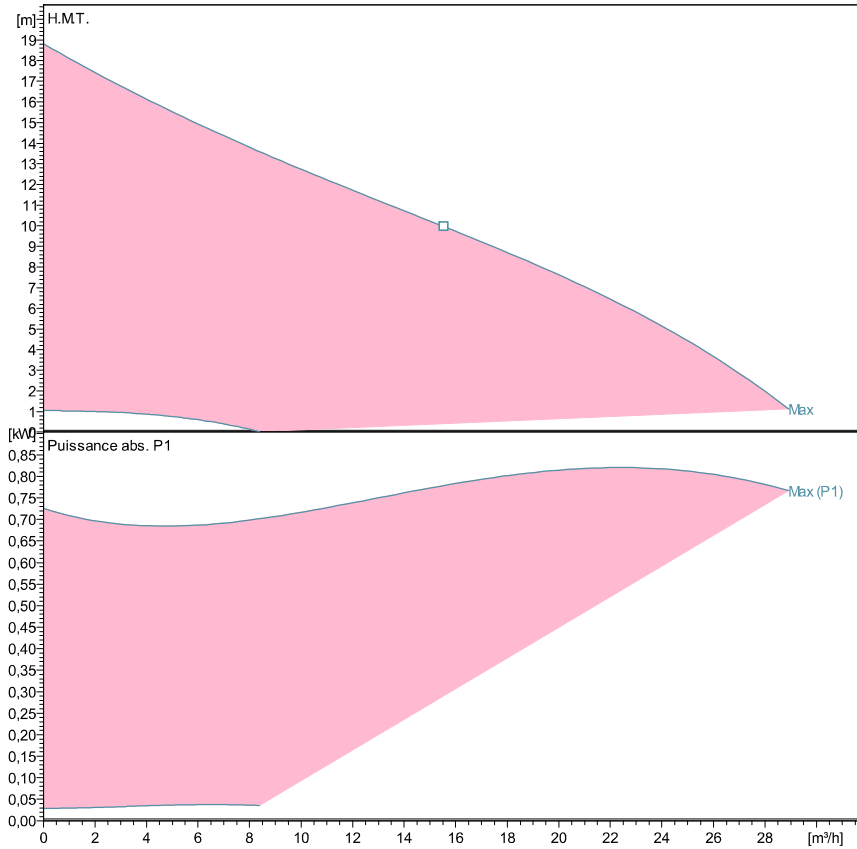

Performances selon ISO 9906: 2012 - Grade 3B

Liquid temperature:

Caract. de puissance d'après:

-10°C (14°F) to +110 °C (230°F) for heating pumps

Eau, claire [100%]; 4°C; 1000kg/m³; 1,57mm²/s

-10°C (14°F) to +85 °C (185°F) for domestic hot water pumps



Caract. pompe

Constructeur	Lowara
Port to port (mm)	250
Electrical connection	Bornes
Specific EEI	<= 0,23
Nominal pressure	PN 6/10
Connection	Bride / DN 40

Electrical data

Tension nom.	230 V
Fréquence	50 / 60
Protection class	IP 44
Classe isolation	F
Digital input	Contact load: 5V, 10 mA
Digital output	Vmax < 250 VAC / Imax < 2 A
Analog input	0-10 V / 4-20 mA
Courant de fuite	< 3.5 mA
Communication capabilities	Pas de protocole de communication
Sound pressure level	<= 52 dB(A)
Intensité nom.	3,7 A

Matériaux

Palier	Carbone, imprégné de résine	roue	PPS
Thrust bearing	Aluminium	Wear ring	Acier inox
Plaque de roult	Acier inox	Rotor can	Acier inox
Carter moteur	Aluminium	Arbre	Acier inox
Joints toriques	EPDM	Boitier	Poly carbonate
Corps de pompe	EN-GJL		

Dimensions mm

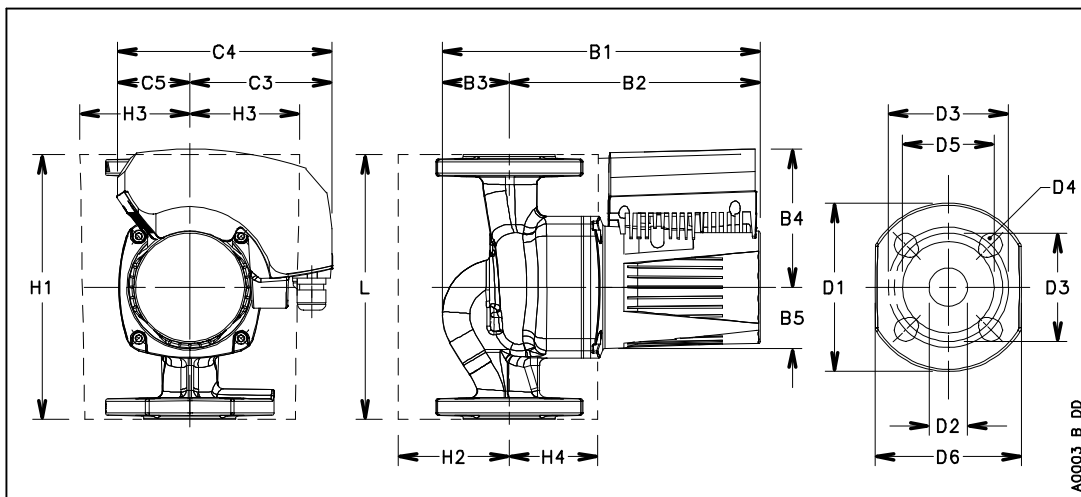

B1	365
B2	299
B3	66
B4	147
B5	61
C3	146
C4	239
C5	93
D1	150
D2	40
D3	100/110
D4	4 x 14/19
D5	84
G	DN 40
Gross Weight	21,6
H1	240
H2	86
H3	90/102
H4	93
L	250
Net Weight	17,8